

WOD-K tetőventilátorok

WOD-K Axiális tetőventilátorok. Alacsony áramlási ellenállású rendszerek szellőztetésére.

Tiszta vagy enyhén szennyezett levegő szállítására.

Energiatakarékos ventilátorok lakótelepek, gyártócsarnokok, üzemek, raktárak, szellőztetésére.

A ventilátorok egyfázisú fordulatszám szabályozható motorral készülnek.

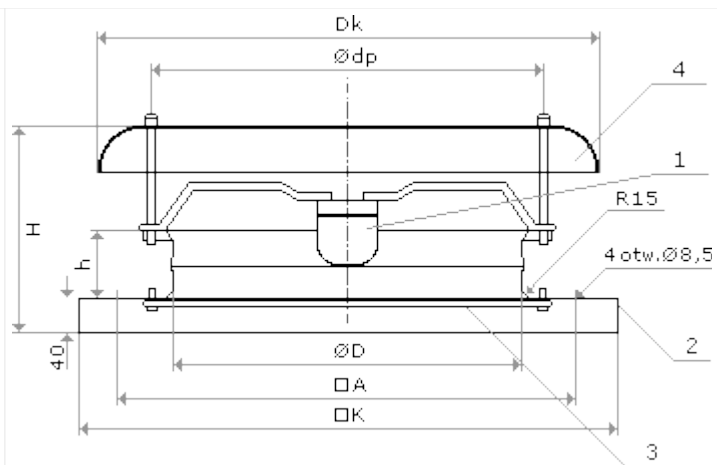

MÉRETEK

Típus	A [mm]	K [mm]	h [mm]	H [mm]	Dk [mm]	Re [mm]	ØD [mm]
WOD-K-315	450	560	80	250 ~	526	414,5	310
WOD-K-355	450	560	80	250 ~	586	414,5	360
WOD-K-400	535	630	80	~ 280	686	455	406
WOD-K-450	535	630	100	~ 280	686	515	462
WOD-K-500	750	900	100	~ 280	800	565	512
WOD-K-560	840	1000	100	~ 280	920	750	572
WOD-K-630	840	1000	150	~ 300	1120	920	642
WOD-K-710	940	1000	~ 120	~ 300	1120	920	722
WOD-K-800	940	1000	~ 150	~ 300	1120	920	812

MŰSZAKI ADATOK

Típus	Kapacitás _{max}		Max [Pa]	Hangerő [dB (A)]		Tömeg [kg]	Teljesítmény [W]	Fordulatszám [min ⁻¹]	Áram [A]	230 V	védelem	Max. üzemi hőmérséklet [° C]
	[M ³ / s]	[M ³ / h]		1m	4m							
WOD-315	0,44	1600	110	62.	50	~ 8	70	1320	0,3	1 ~	IP 44	70
WOD-355	0,75	2700	190	65.	53	~ 8	140	1370	0,7	1 ~	IP 44	50
WOD-400	1,00	3600	270	62.	50	~ 12	195	1450	1,0	1 ~	IP 54	70
WOD-450	1,42	5100	230	72	60	~ 18	345	1430	1,6	1 ~	IP 54	75
WOD-500	2,22	8000	230	76	66.	~ 22	570	1350	2,5	1 ~	IP 54	75
WOD-560	2,50	9000	135	69	60	~ 20	450	910	2,0	1 ~	IP 54	50
WOD-630	2,78	10000	190	76	61.	~ 22	530	910	2,5	1 ~	IP 54	55
WOD-710	5,00	18000	240	70	62.	~ 26	1100	860	2,4	1 ~	IP 54	55
WOD-800	5,56	20000	220	72	63	~ 34	1300	880	3,2	3 ~	IP 54	50

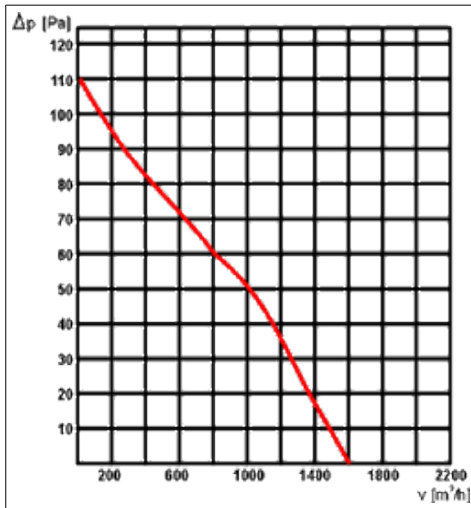

WOD-K-315

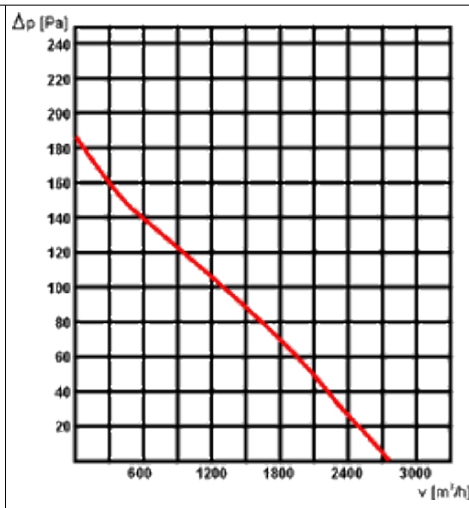

WOD-K-355

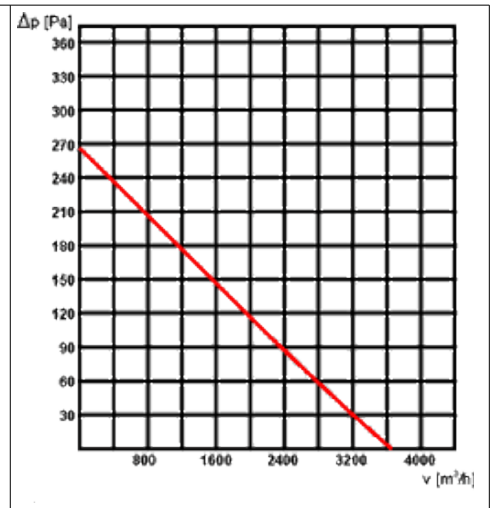

WOD-K-400

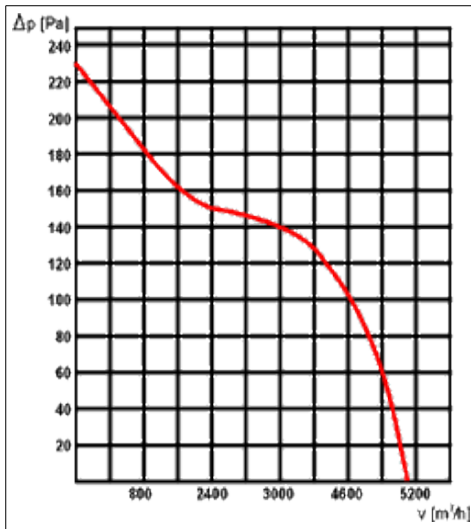

WOD-K-450

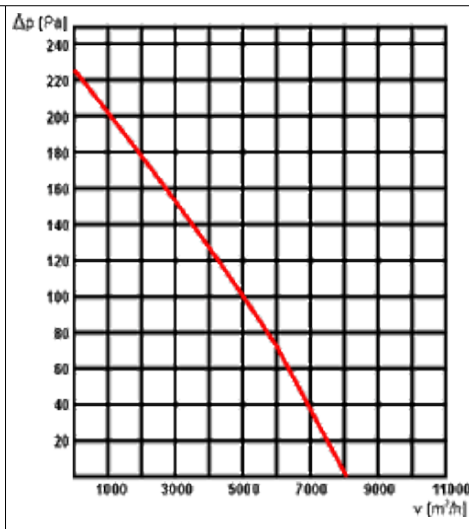

WOD-K-500

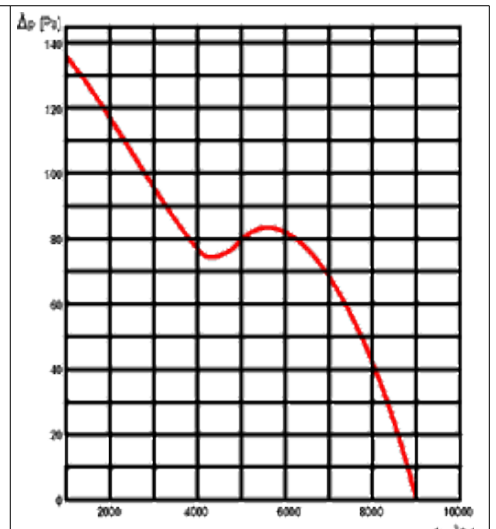

WOD-K-560

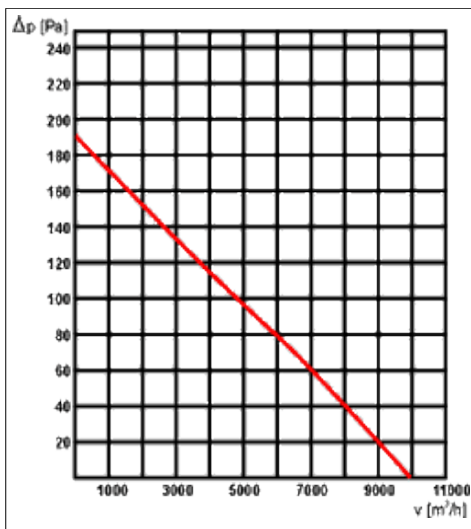

WOD-K-630

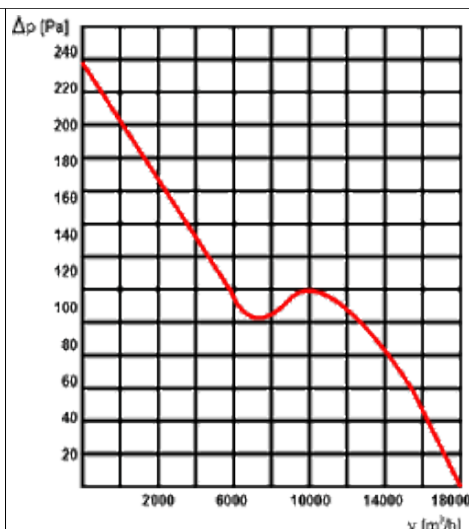

WOD-K-710

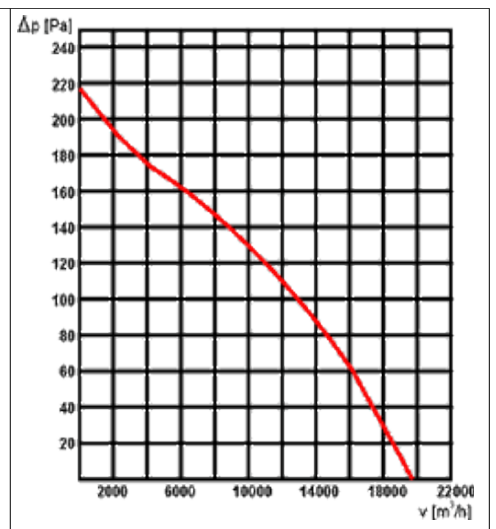

WOD-K-800