

WPS radiál-dobventilátorok

Folyamatos üzemmódra tervezett, szennyezett közeg szállítására is alkalmas radiál ventilátorcsalád közvetlen lapátmeghajtással. A szállított levegő hőmérséklete -25 C és +60 C között lehet. Alkalmazás: gyárak, csarnokok, mezőgazdasági létesítmények, szellőztetésére. Fűtési rendszerekbe.

Az 1 fázisú motorok feszültség alapú szabályzással, a 3-fázisú motorok frekvenciaváltóval szabályozhatóak. Motor védelem IP 55. A ventilátor ház poliészter bevonatú acél. Acél vagy alumínium járókerék.

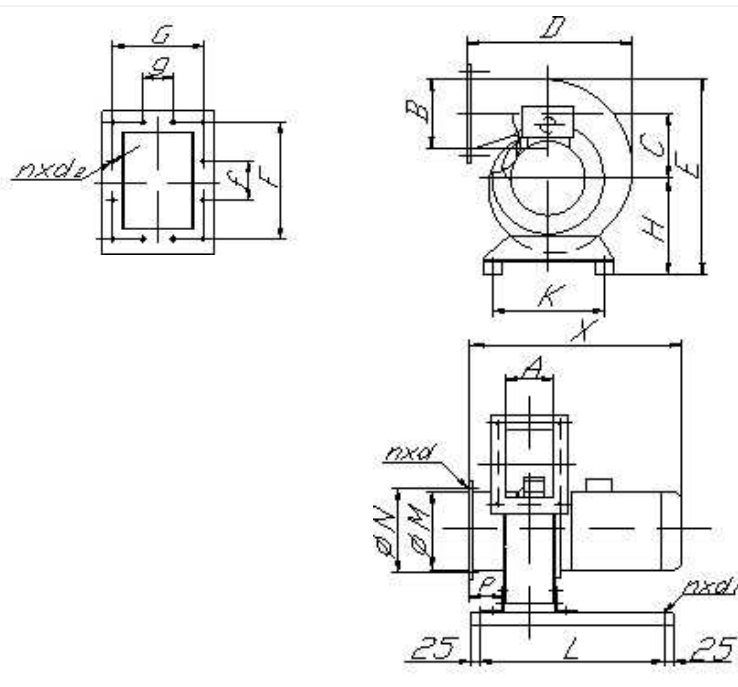

Típus:	A	B	C	D	E	H	K	M	N	n x d	J	L	X	n x d1	G	g	F	f	n x d2
WPS-16 A	125	125	109	285	325	153	180	160	185	8x7	40	350	375	2x7	149	-	149	-	4x7
WPS-16 B	125	180	138	360	415	184	200	160	185	8x7	40	350	375	2x10	149	-	204	140	6x7
WPS-20 AN	200	315	264	653	767	345	350	200	225	8x7	50	400	520	2x12	232	140	347	140	12x10
WPS-20 BN	140	315	264	653	767	345	350	200	225	8x7	60	400	470	2x12	172	-	347	140	8x10
WPS-25 AN	140	315	264	653	767	345	350	250	275	8x7	60	450	430	2x12	172	-	347	140	8x10
WPS-25 BN	140	315	264	653	767	345	350	250	275	8x7	60	450	495	2x12	172	-	347	140	8x10
WPS-25 CN	200	315	264	653	767	345	350	250	275	8x7	50	450	585	2x12	232	140	347	140	12x10
WPS-25 DN	315	315	303	750	840	380	500	250	275	8x7	60	600	700	2x14	347	140	347	140	12x10
WPS-25 E	150	150	379	784	876	422	400	250	275	8x7	100	700	650	4x12	184	-	184	-	4x10
WPS-31 AN	200	315	264	653	767	345	350	315	340	8x7	60	550	520	2x12	232	140	347	140	12x10
WPS-31 BN	200	315	264	653	767	345	350	315	340	8x7	60	550	555	2x12	232	140	347	140	12x10
WPS-31 C	250	315	303	750	840	380	500	315	340	8x7	60	550	710	2x12	282	140	347	140	12x10
WPS-35 A	315	355	345	817	942	420	550	355	387	12x10	100	550	770	2x12	347	140	387	140	12x10
WPS-35 B	315	355	345	817	942	420	550	355	387	12x10	100	550	770	2x12	347	140	387	140	12x10
WPS-40 A	250	400	350	860	990	440	550	400	446	12x12	100	600	675	2x12	282	140	432	140	12x10
WPS-40 BN	400	450	413	990	1140	500	650	400	446	12x12	100	900	900	2x14	432	140	482	140	12x10
WPS-40 C	400	450	413	990	1140	500	650	400	446	12x12	100	900	900	2x14	432	140	482	140	12x10
WPS-45 A	400	560	473	1170	1340	590	750	450	523	12x15	100	950	900	2x14	432	140	592	140	16x10
WPS-45 B	450	560	473	1170	1340	590	750	450	523	12x15	100	950	900	2x14	432	140	592	140	16x10

Típus:	m3/h (max.)	m3/h (nom.)	Pa (nom.)	zajszint dB(A)	Kw	ford./perc	1*230V (A)	3*400V (A)	Súly (Kg)
WPS-16 A	684	300	150	63	0,12	2800	1	0,36	14
WPS-16 B	923	600	200	70	0,18	2800	1,6	0,62	18
WPS-20 AN	2000	1000	200	65	0,18	900	-	0,59	37
WPS-20 BN	3900	3200	1100	98	2,2	2800	-	4,6	40
WPS-25 AN	2100	1600	250	68	0,25	1400	1,9	0,71	35
WPS-25 BN	4150	3200	1200	98	2,2	2800	-	4,6	42
WPS-25 CN	7500	5500	1200	99	3,0	2800	-	6	60
WPS-25 DN	5200	3800	580	85	1,1	1400	7,2	2,7	73
WPS-25 E	9000	5500	3000	101	7,5	2800	-	13,7	170
WPS-31 AN	3500	2900	235	86	0,37	1400	2,9	0,98	35
WPS-31 BN	7550	6000	1200	99	3,0	2800	-	6	55
WPS-31 C	9400	5400	1600	100	5,5	2800	-	10,3	113
WPS-35 A	8280	4850	370	81	1,5	1400	9,3	3,4	79
WPS-35 B	16210	9470	1440	98	7,5	2800	-	13,7	135
WPS-40 A	7500	5470	960	85	3,0	1400	-	6,5	105
WPS-40 BN	11200	5000	300	83	1,5	900	-	3,8	123
WPS-40 C	16000	8100	820	93	4,0	1400	-	8,1	135
WPS-45 A	17800	10000	550	88	2,2	900	-	5,4	129
WPS-45 B	22500	13000	1200	95	7,5	1400	-	14,4	149

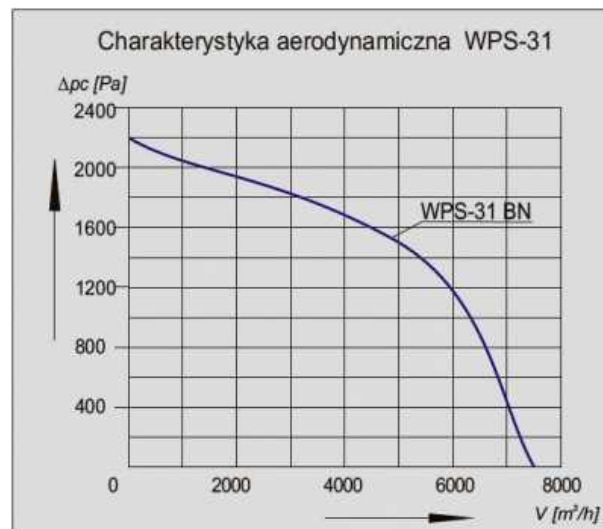
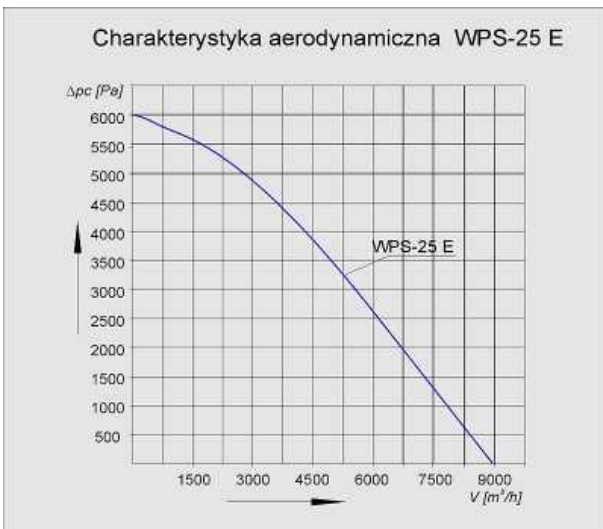
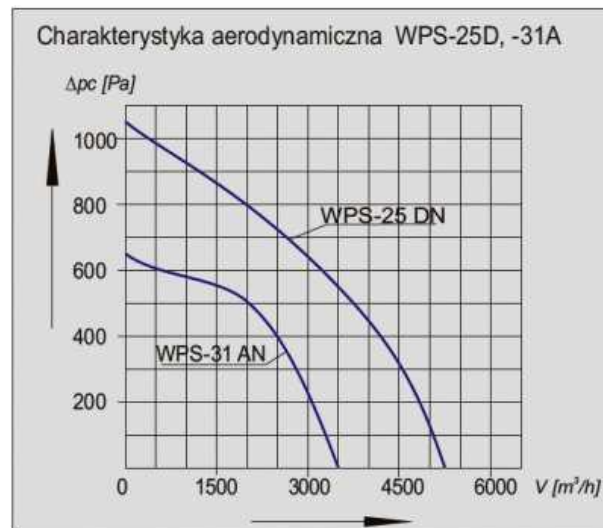
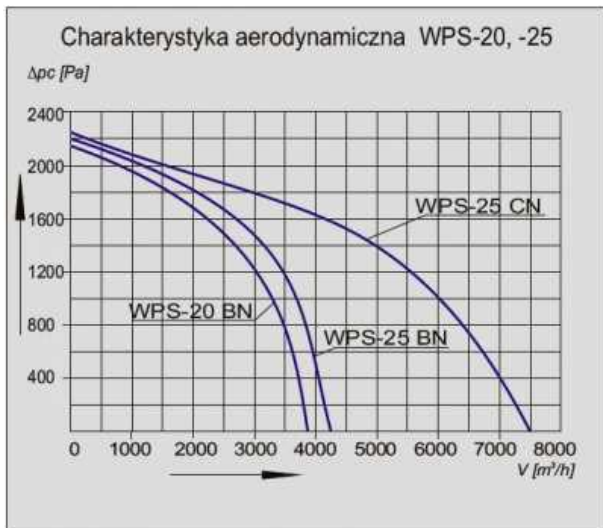
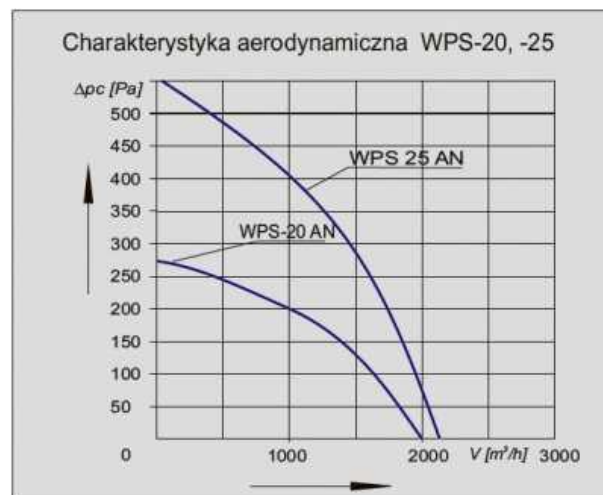
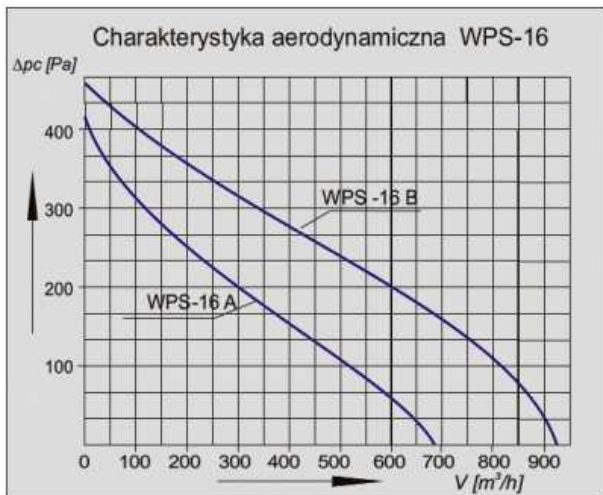

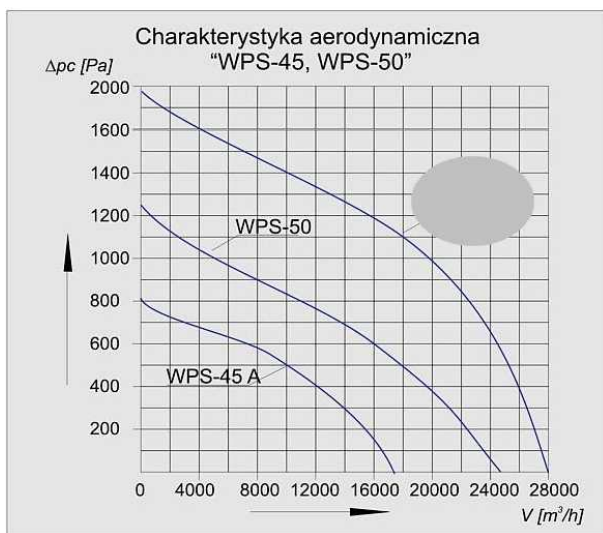
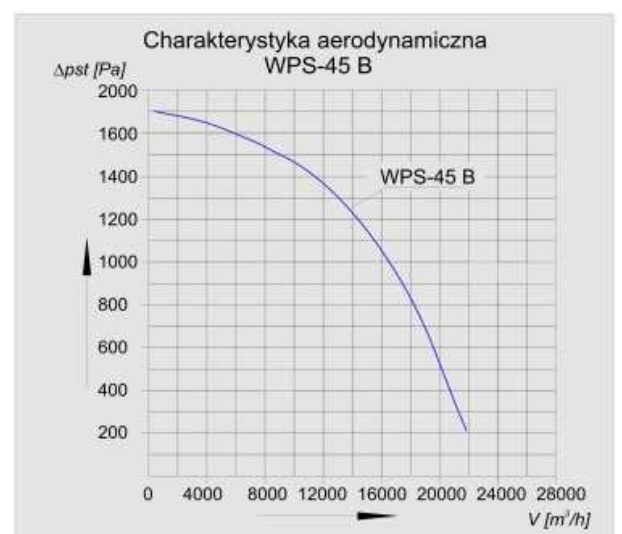
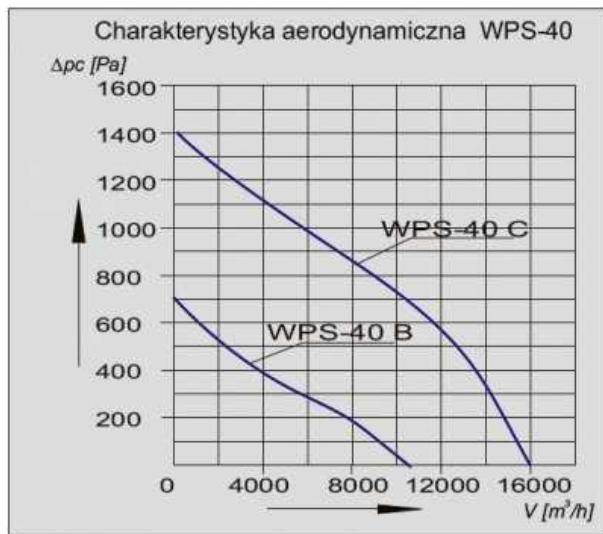
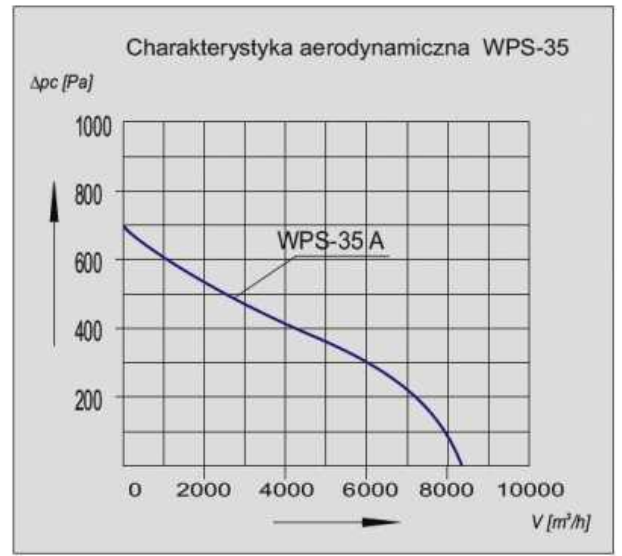
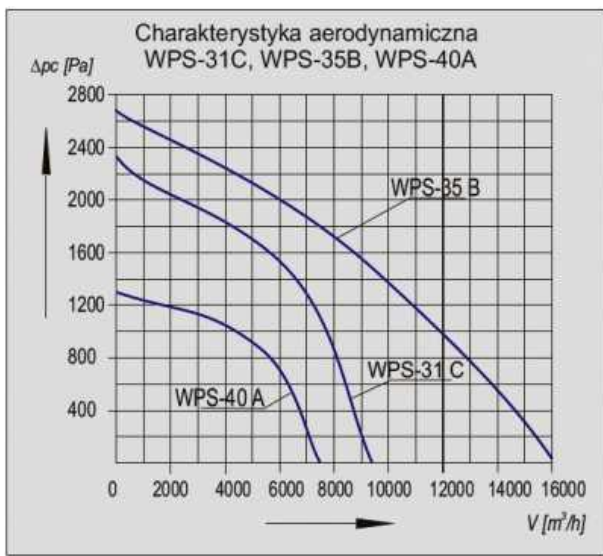

Választható gyártási pozíciók: Alapesetben a ventilátor LG 90 (L2) pozícióban kerül legyártásra.

